

Features

- **HIGH PERFORMANCE E²CMOS® TECHNOLOGY**
 - 3.5 ns Maximum Propagation Delay
 - F_{max} = 250 MHz
 - 3.0 ns Maximum from Clock Input to Data Output
 - UltraMOS® Advanced CMOS Technology
- **50% to 75% REDUCTION IN POWER FROM BIPOLAR**
 - 75mA Typ I_{cc} on Low Power Device
 - 45mA Typ I_{cc} on Quarter Power Device
- **ACTIVE PULL-UPS ON ALL PINS**
- **E² CELL TECHNOLOGY**
 - Reconfigurable Logic
 - Reprogrammable Cells
 - 100% Tested/100% Yields
 - High Speed Electrical Erasure (<100ms)
 - 20 Year Data Retention
- **EIGHT OUTPUT LOGIC MACROCELLS**
 - Maximum Flexibility for Complex Logic Designs
 - Programmable Output Polarity
 - Also Emulates 20-pin PAL® Devices with Full Function/Fuse Map/Parametric Compatibility
- **PRELOAD AND POWER-ON RESET OF ALL REGISTERS**
 - 100% Functional Testability
- **APPLICATIONS INCLUDE:**
 - DMA Control
 - State Machine Control
 - High Speed Graphics Processing
 - Standard Logic Speed Upgrade
- **ELECTRONIC SIGNATURE FOR IDENTIFICATION**

Functional Block Diagram

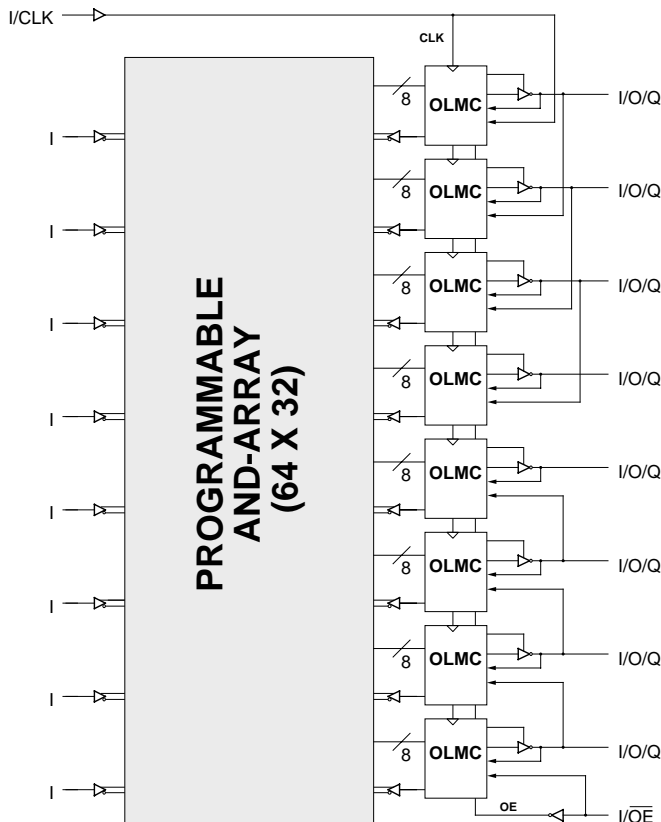

Description

The GAL16V8, at 3.5 ns maximum propagation delay time, combines a high performance CMOS process with Electrically Erasable (E²) floating gate technology to provide the highest speed performance available in the PLD market. High speed erase times (<100ms) allow the devices to be reprogrammed quickly and efficiently.

The generic architecture provides maximum design flexibility by allowing the Output Logic Macrocell (OLMC) to be configured by the user. An important subset of the many architecture configurations possible with the GAL16V8 are the PAL architectures listed in the table of the macrocell description section. GAL16V8 devices are capable of emulating any of these PAL architectures with full function/fuse map/parametric compatibility.

Unique test circuitry and reprogrammable cells allow complete AC, DC, and functional testing during manufacture. As a result, Lattice Semiconductor delivers 100% field programmability and functionality of all GAL products. In addition, 100 erase/write cycles and data retention in excess of 20 years are specified.

Pin Configuration

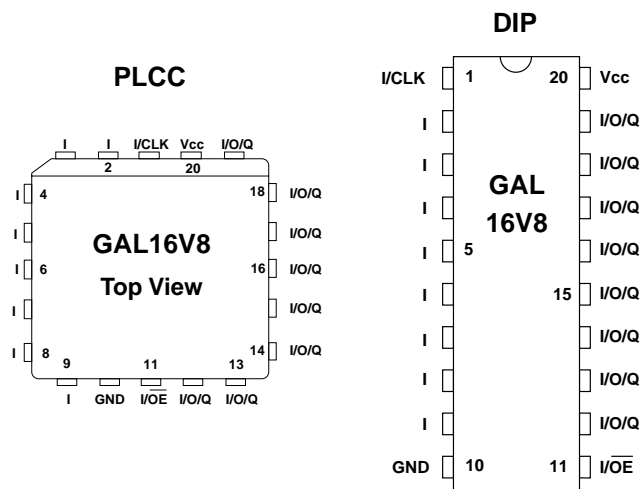

Copyright © 1998 Lattice Semiconductor Corp. All brand or product names are trademarks or registered trademarks of their respective holders. The specifications and information herein are subject to change without notice.

GAL16V8 Ordering Information

Commercial Grade Specifications

| Tpd (ns) | Tsu (ns) | Tco (ns) | Icc (mA) | Ordering # | Package |
|----------|----------|----------|----------|---------------|--------------------|
| 3.5 | 2.5 | 3.0 | 115 | GAL16V8D-3LJ | 20-Lead PLCC |
| 5 | 3 | 4 | 115 | GAL16V8D-5LJ | 20-Lead PLCC |
| 7.5 | 7 | 5 | 115 | GAL16V8D-7LP | 20-Pin Plastic DIP |
| | | | 115 | GAL16V8D-7LJ | 20-Lead PLCC |
| 10 | 10 | 7 | 55 | GAL16V8D-10QP | 20-Pin Plastic DIP |
| | | | 55 | GAL16V8D-10QJ | 20-Lead PLCC |
| | | | 115 | GAL16V8D-10LP | 20-Pin Plastic DIP |
| | | | 115 | GAL16V8D-10LJ | 20-Lead PLCC |
| 15 | 12 | 10 | 55 | GAL16V8D-15QP | 20-Pin Plastic DIP |
| | | | 55 | GAL16V8D-15QJ | 20-Lead PLCC |
| | | | 90 | GAL16V8D-15LP | 20-Pin Plastic DIP |
| | | | 90 | GAL16V8D-15LJ | 20-Lead PLCC |
| 25 | 15 | 12 | 55 | GAL16V8D-25QP | 20-Pin Plastic DIP |
| | | | 55 | GAL16V8D-25QJ | 20-Lead PLCC |
| | | | 90 | GAL16V8D-25LP | 20-Pin Plastic DIP |
| | | | 90 | GAL16V8D-25LJ | 20-Lead PLCC |

Industrial Grade Specifications

| Tpd (ns) | Tsu (ns) | Tco (ns) | Icc (mA) | Ordering # | Package |
|----------|----------|----------|----------|----------------|--------------------|
| 7.5 | 7 | 5 | 130 | GAL16V8D-7LPI | 20-Pin Plastic DIP |
| | | | 130 | GAL16V8D-7LJI | 20-Lead PLCC |
| 10 | 10 | 7 | 130 | GAL16V8D-10LPI | 20-Pin Plastic DIP |
| | | | 130 | GAL16V8D-10LJI | 20-Lead PLCC |
| 15 | 12 | 10 | 130 | GAL16V8D-15LPI | 20-Pin Plastic DIP |
| | | | 130 | GAL16V8D-15LJI | 20-Lead PLCC |
| 20 | 13 | 11 | 65 | GAL16V8D-20QPI | 20-Pin Plastic DIP |
| | | | 65 | GAL16V8D-20QJI | 20-Lead PLCC |
| 25 | 15 | 12 | 65 | GAL16V8D-25QPI | 20-Pin Plastic DIP |
| | | | 65 | GAL16V8D-25QJI | 20-Lead PLCC |
| | | | 130 | GAL16V8D-25LPI | 20-Pin Plastic DIP |
| | | | 130 | GAL16V8D-25LJI | 20-Lead PLCC |

Part Number Description

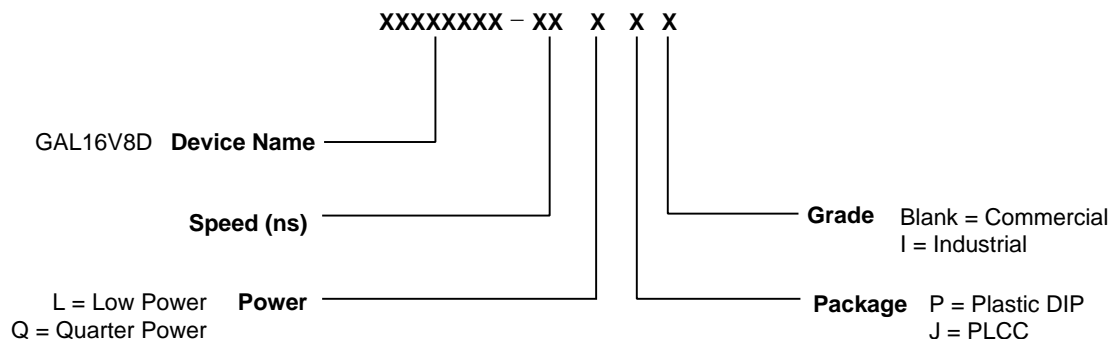

Output Logic Macrocell (OLMC)

The following discussion pertains to configuring the output logic macrocell. It should be noted that actual implementation is accomplished by development software/hardware and is completely transparent to the user.

There are three global OLMC configuration modes possible: **simple**, **complex**, and **registered**. Details of each of these modes are illustrated in the following pages. Two global bits, SYN and AC0, control the mode configuration for all macrocells. The XOR bit of each macrocell controls the polarity of the output in any of the three modes, while the AC1 bit of each of the macrocells controls the input/output configuration. These two global and 16 individual architecture bits define all possible configurations in a GAL16V8. The information given on these architecture bits is only to give a better understanding of the device. Compiler software will transparently set these architecture bits from the pin definitions, so the user should not need to directly manipulate these architecture bits.

The following is a list of the PAL architectures that the GAL16V8 can emulate. It also shows the OLMC mode under which the GAL16V8 emulates the PAL architecture.

| PAL Architectures Emulated by GAL16V8 | GAL16V8 Global OLMC Mode |
|---------------------------------------|--------------------------|
| 16R8 | Registered |
| 16R6 | Registered |
| 16R4 | Registered |
| 16RP8 | Registered |
| 16RP6 | Registered |
| 16RP4 | Registered |
| 16L8 | Complex |
| 16H8 | Complex |
| 16P8 | Complex |
| 10L8 | Simple |
| 12L6 | Simple |
| 14L4 | Simple |
| 16L2 | Simple |
| 10H8 | Simple |
| 12H6 | Simple |
| 14H4 | Simple |
| 16H2 | Simple |
| 10P8 | Simple |
| 12P6 | Simple |
| 14P4 | Simple |
| 16P2 | Simple |

Compiler Support for OLMC

Software compilers support the three different global OLMC modes as different device types. These device types are listed in the table below. Most compilers have the ability to automatically select the device type, generally based on the register usage and output enable (OE) usage. Register usage on the device forces the software to choose the registered mode. All combinatorial outputs with OE controlled by the product term will force the software to choose the complex mode. The software will choose the simple mode only when all outputs are dedicated combinatorial without OE control. The different device types listed in the table can be used to override the automatic device selection by the software. For further details, refer to the compiler software manuals.

When using compiler software to configure the device, the user must pay special attention to the following restrictions in each mode. In **registered mode** pin 1 and pin 11 are permanently configured

as clock and output enable, respectively. These pins cannot be configured as dedicated inputs in the registered mode.

In **complex mode** pin 1 and pin 11 become dedicated inputs and use the feedback paths of pin 19 and pin 12 respectively. Because of this feedback path usage, pin 19 and pin 12 do not have the feedback option in this mode.

In **simple mode** all feedback paths of the output pins are routed via the adjacent pins. In doing so, the two inner most pins (pins 15 and 16) will not have the feedback option as these pins are always configured as dedicated combinatorial output.

| | Registered | Complex | Simple | Auto Mode Select |
|------------|---------------------------|------------------------|-----------------------|------------------|
| ABEL | P16V8R | P16V8C | P16V8AS | P16V8 |
| CUPL | G16V8MS | G16V8MA | G16V8AS | G16V8 |
| LOG/iC | GAL16V8_R | GAL16V8_C7 | GAL16V8_C8 | GAL16V8 |
| OrCAD-PLD | "Registered" ¹ | "Complex" ¹ | "Simple" ¹ | GAL16V8A |
| PLDesigner | P16V8R ² | P16V8C ² | P16V8C ² | P16V8A |
| TANGO-PLD | G16V8R | G16V8C | G16V8AS ³ | G16V8 |

1) Used with **Configuration** keyword.
 2) Prior to Version 2.0 support.
 3) Supported on Version 1.20 or later.

Registered Mode

In the Registered mode, macrocells are configured as dedicated registered outputs or as I/O functions.

Architecture configurations available in this mode are similar to the common 16R8 and 16RP4 devices with various permutations of polarity, I/O and register placement.

All registered macrocells share common clock and output enable control pins. Any macrocell can be configured as registered or I/O. Up to eight registers or up to eight I/O's are possible in this mode.

Dedicated input or output functions can be implemented as subsets of the I/O function.

Registered outputs have eight product terms per output. I/O's have seven product terms per output.

The JEDEC fuse numbers, including the User Electronic Signature (UES) fuses and the Product Term Disable (PTD) fuses, are shown on the logic diagram on the following page.

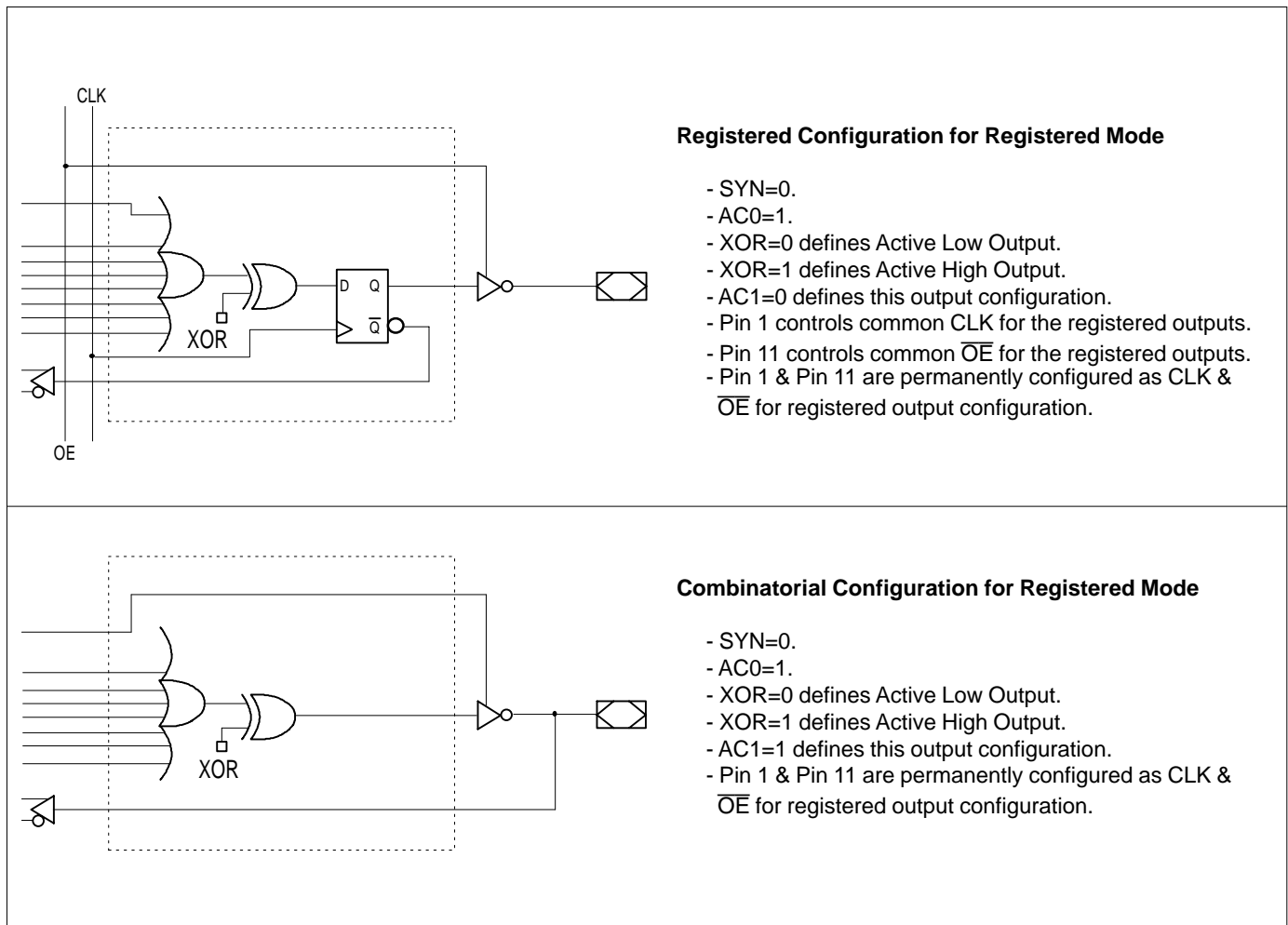

Note: The development software configures all of the architecture control bits and checks for proper pin usage automatically.

Registered Mode Logic Diagram

DIP & PLCC Package Pinouts

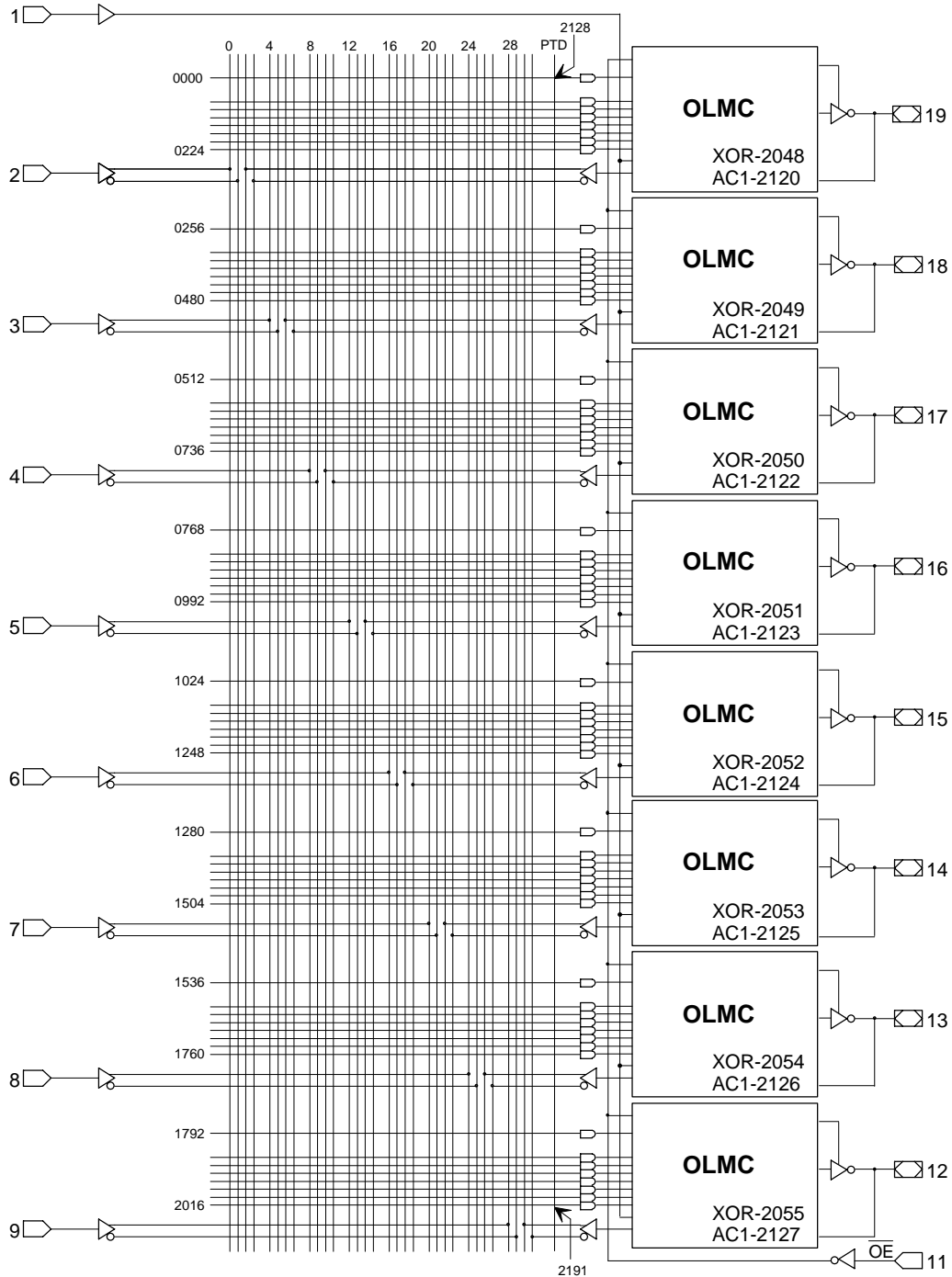

64-USER ELECTRONIC SIGNATURE FUSES

| | |
|------------------------|----------------------|
| 2056, 2057, | 2118, 2119 |
| Byte 7 Byte 6 | Byte 1 Byte 0 |
| M | L |
| S | S |
| B | B |

SYN-2192
AC0-2193

Complex Mode

In the Complex mode, macrocells are configured as output only or I/O functions.

Architecture configurations available in this mode are similar to the common 16L8 and 16P8 devices with programmable polarity in each macrocell.

Up to six I/O's are possible in this mode. Dedicated inputs or outputs can be implemented as subsets of the I/O function. The two outer most macrocells (pins 12 & 19) do not have input capa-

bility. Designs requiring eight I/O's can be implemented in the Registered mode.

All macrocells have seven product terms per output. One product term is used for programmable output enable control. Pins 1 and 11 are always available as data inputs into the AND array.

The JEDEC fuse numbers including the UES fuses and PTD fuses are shown on the logic diagram on the following page.

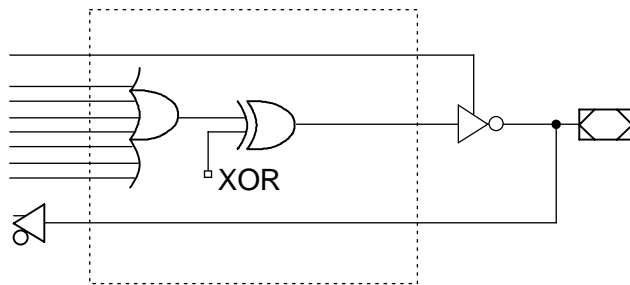

Combinatorial I/O Configuration for Complex Mode

- SYN=1.
- AC0=1.
- XOR=0 defines Active Low Output.
- XOR=1 defines Active High Output.
- AC1=1.
- Pin 13 through Pin 18 are configured to this function.

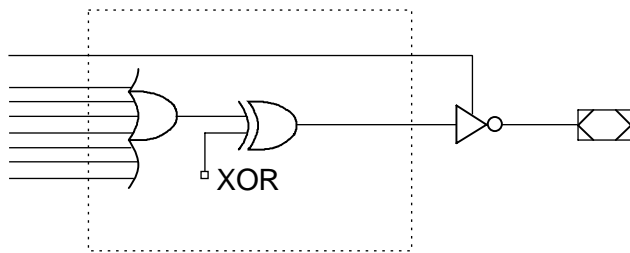

Combinatorial Output Configuration for Complex Mode

- SYN=1.
- AC0=1.
- XOR=0 defines Active Low Output.
- XOR=1 defines Active High Output.
- AC1=1.
- Pin 12 and Pin 19 are configured to this function.

Note: The development software configures all of the architecture control bits and checks for proper pin usage automatically.

Complex Mode Logic Diagram

DIP & PLCC Package Pinouts

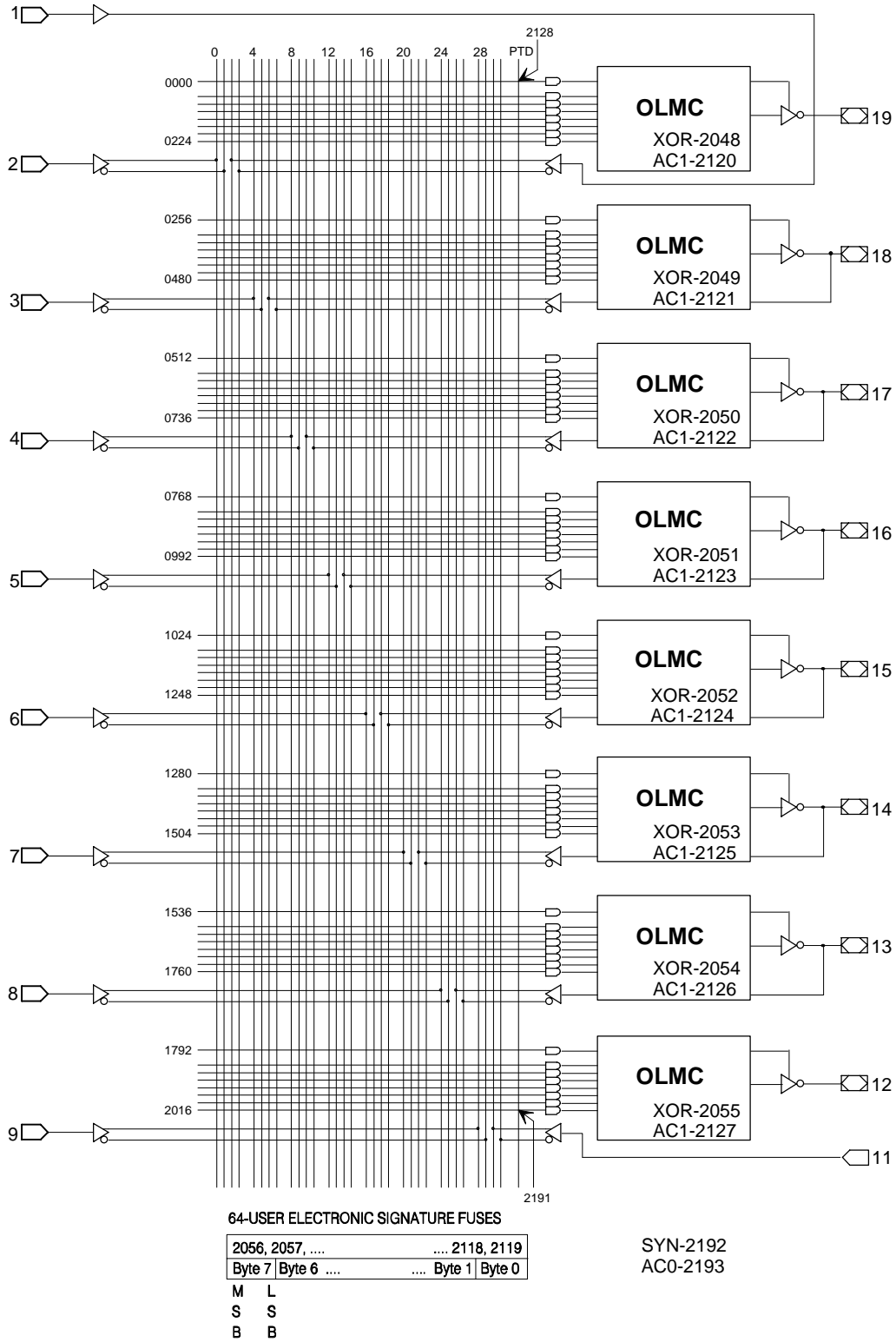

Simple Mode

In the Simple mode, macrocells are configured as dedicated inputs or as dedicated, always active, combinatorial outputs.

Architecture configurations available in this mode are similar to the common 10L8 and 12P6 devices with many permutations of generic output polarity or input choices.

All outputs in the simple mode have a maximum of eight product terms that can control the logic. In addition, each output has programmable polarity.

Pins 1 and 11 are always available as data inputs into the AND array. The center two macrocells (pins 15 & 16) cannot be used as input or I/O pins, and are only available as dedicated outputs.

The JEDEC fuse numbers including the UES fuses and PTD fuses are shown on the logic diagram.

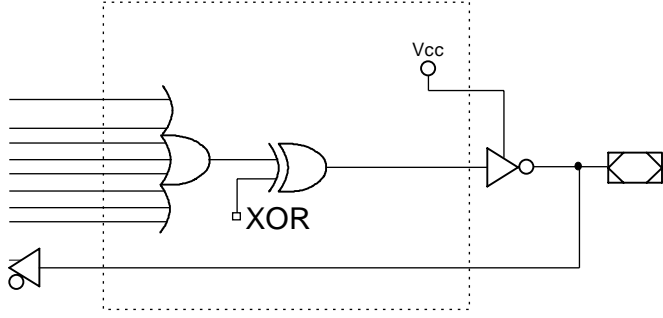
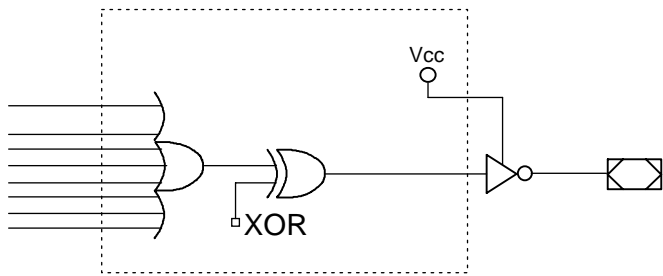
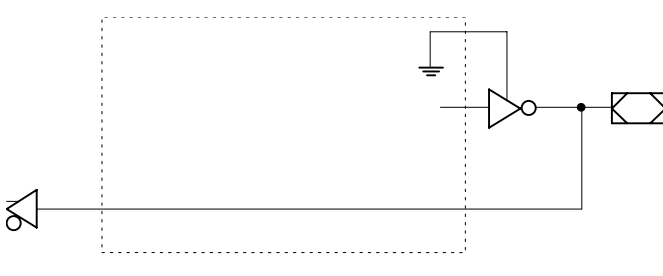
| | |
|---|--|
|  | <p>Combinatorial Output with Feedback Configuration for Simple Mode</p> <ul style="list-style-type: none"> - SYN=1. - AC0=0. - XOR=0 defines Active Low Output. - XOR=1 defines Active High Output. - AC1=0 defines this configuration. - All OLMC except pins 15 & 16 can be configured to this function. |
|  | <p>Combinatorial Output Configuration for Simple Mode</p> <ul style="list-style-type: none"> - SYN=1. - AC0=0. - XOR=0 defines Active Low Output. - XOR=1 defines Active High Output. - AC1=0 defines this configuration. - Pins 15 & 16 are permanently configured to this function. |
|  | <p>Dedicated Input Configuration for Simple Mode</p> <ul style="list-style-type: none"> - SYN=1. - AC0=0. - XOR=0 defines Active Low Output. - XOR=1 defines Active High Output. - AC1=1 defines this configuration. - All OLMC except pins 15 & 16 can be configured to this function. |

Note: The development software configures all of the architecture control bits and checks for proper pin usage automatically.

Simple Mode Logic Diagram

DIP & PLCC Package Pinouts

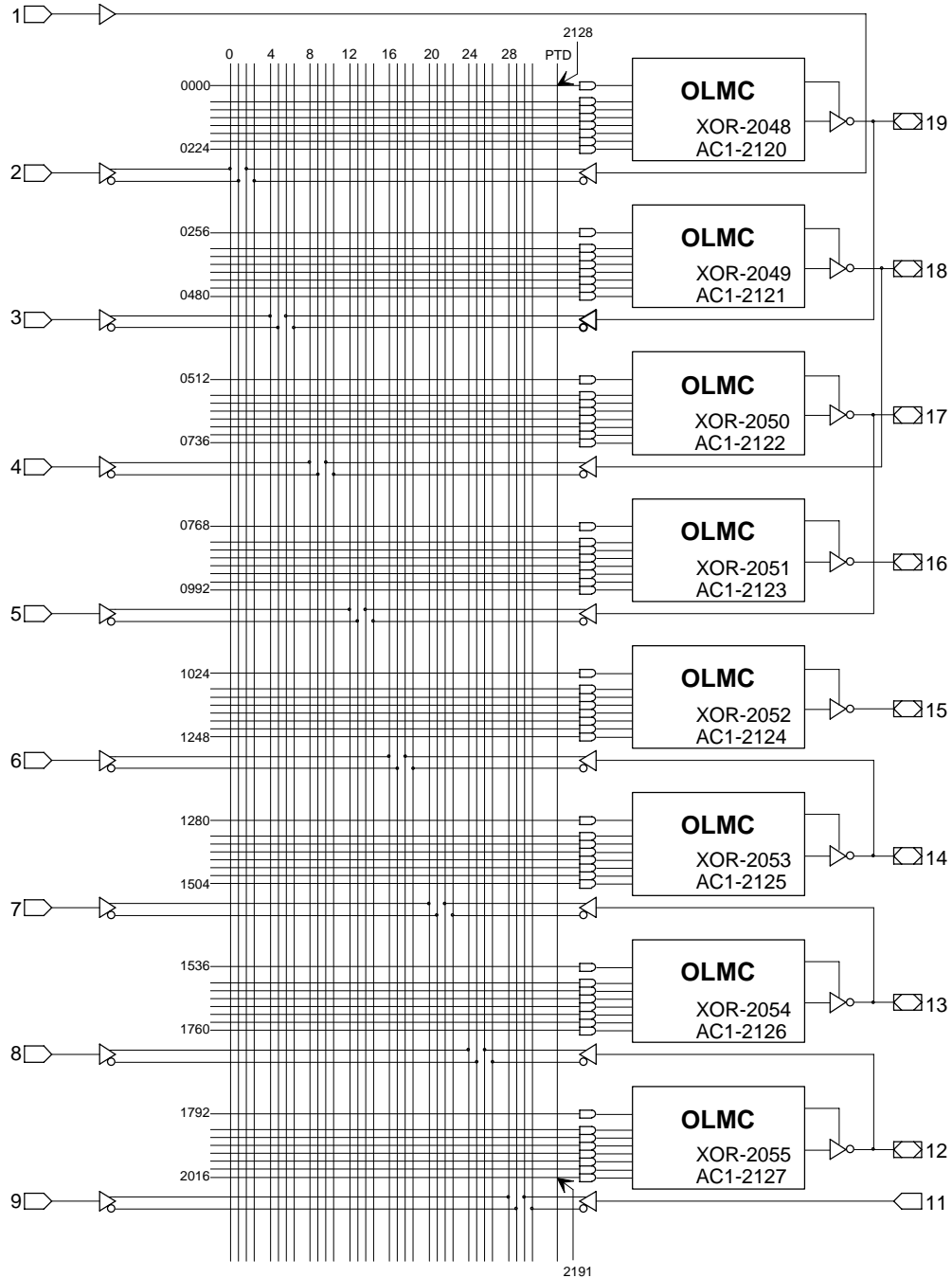

64-USER ELECTRONIC SIGNATURE FUSES

| | |
|----------------------|----------------------|
| 2056, 2057, | 2118, 2119 |
| Byte 7 Byte 6 | Byte 1 Byte 0 |

SYN-2192
AC0-2193

M L
S S
B B

Absolute Maximum Ratings⁽¹⁾

Supply voltage V_{CC} -0.5 to +7V
 Input voltage applied -2.5 to $V_{CC} + 1.0V$
 Off-state output voltage applied -2.5 to $V_{CC} + 1.0V$
 Storage Temperature -65 to 150°C
 Ambient Temperature with
 Power Applied -55 to 125°C

1. Stresses above those listed under the “Absolute Maximum Ratings” may cause permanent damage to the device. These are stress only ratings and functional operation of the device at these or at any other conditions above those indicated in the operational sections of this specification is not implied (while programming, follow the programming specifications).

Recommended Operating Conditions

Commercial Devices:

Ambient Temperature (T_A) 0 to 75°C
 Supply voltage (V_{CC})
 with Respect to Ground +4.75 to +5.25V

Industrial Devices:

Ambient Temperature (T_A) -40 to 85°C
 Supply voltage (V_{CC})
 with Respect to Ground +4.50 to +5.50V

DC Electrical Characteristics

Over Recommended Operating Conditions (Unless Otherwise Specified)

| SYMBOL | PARAMETER | CONDITION | MIN. | TYP. ³ | MAX. | UNITS |
|-----------------------------------|-----------------------------------|---|----------------|-------------------|--------------|-------|
| V_{IL} | Input Low Voltage | | $V_{SS} - 0.5$ | — | 0.8 | V |
| V_{IH} | Input High Voltage | | 2.0 | — | $V_{CC} + 1$ | V |
| I_{IL}¹ | Input or I/O Low Leakage Current | $0V \leq V_{IN} \leq V_{IL} (MAX.)$ | — | — | -100 | μA |
| I_{IH} | Input or I/O High Leakage Current | $3.5V \leq V_{IN} \leq V_{CC}$ | — | — | 10 | μA |
| V_{OL} | Output Low Voltage | $I_{OL} = MAX. V_{IN} = V_{IL} \text{ or } V_{IH}$ | — | — | 0.5 | V |
| V_{OH} | Output High Voltage | $I_{OH} = MAX. V_{IN} = V_{IL} \text{ or } V_{IH}$ | 2.4 | — | — | V |
| I_{OL} | Low Level Output Current | L-3/-5 & -7 (Ind. PLCC) | — | — | 16 | mA |
| | | L-7 (Except Ind. PLCC)/-10/-15/-25 | — | — | 24 | mA |
| | | Q-10/-15/-20/-25 | — | — | — | — |
| I_{OH} | High Level Output Current | | — | — | -3.2 | mA |
| I_{OS}² | Output Short Circuit Current | $V_{CC} = 5V \quad V_{OUT} = 0.5V \quad T_A = 25^\circ C$ | -30 | — | -150 | mA |

COMMERCIAL

| I _{CC} | Operating Power Supply Current | V _{IL} = 0.5V V _{IH} = 3.0V f _{toggle} = 15MHz Outputs Open | L-3/-5/-7/-10 | — | 75 | 115 | mA |
|-----------------|-----------------------------------|---|---------------|---|----|-----|----|
| | | | L-15/-25 | — | 75 | 90 | mA |
| | | | Q-10/-15/-25 | — | 45 | 55 | mA |

INDUSTRIAL

| I _{CC} | Operating Power Supply Current | V _{IL} = 0.5V V _{IH} = 3.0V f _{toggle} = 15MHz Outputs Open | L-7/-10/-15/-25 | — | 75 | 130 | mA |
|-----------------|-----------------------------------|---|-----------------|---|----|-----|----|
| | | | Q-20/-25 | — | 45 | 65 | mA |

- 1) The leakage current is due to the internal pull-up resistor on all pins. See **Input Buffer** section for more information.
- 2) One output at a time for a maximum duration of one second. $V_{out} = 0.5V$ was selected to avoid test problems caused by tester ground degradation. Characterized but not 100% tested.
- 3) Typical values are at $V_{CC} = 5V$ and $T_A = 25^\circ C$

AC Switching Characteristics

Over Recommended Operating Conditions

| PARAMETER | TEST COND ¹ . | DESCRIPTION | COM | | COM | | COM / IND | | UNITS |
|------------------------------------|--------------------------|--|----------------|------|----------------|------|-----------|------|-------|
| | | | -3 | | -5 | | -7 | | |
| | | | MIN. | MAX. | MIN. | MAX. | MIN. | MAX. | |
| t_{pd} | A | Input or I/O to Comb. Output | 1 | 3.5 | 1 | 5 | 1 | 7.5 | ns |
| t_{co} | A | Clock to Output Delay | 1 | 3 | 1 | 4 | 1 | 5 | ns |
| t_{cf}² | — | Clock to Feedback Delay | — | 2.5 | — | 3 | — | 3 | ns |
| t_{su} | — | Setup Time, Input or Feedback before Clock [↑] | 2.5 | — | 3 | — | 7 | — | ns |
| t_h | — | Hold Time, Input or Feedback after Clock [↑] | 0 | — | 0 | — | 0 | — | ns |
| f_{max}³ | A | Maximum Clock Frequency with External Feedback, 1/(t _{su} + t _{co}) | 182 | — | 142.8 | — | 83.3 | — | MHz |
| | A | Maximum Clock Frequency with Internal Feedback, 1/(t _{su} + t _{cf}) | 200 | — | 166 | — | 100 | — | MHz |
| | A | Maximum Clock Frequency with No Feedback | 250 | — | 166 | — | 100 | — | MHz |
| t_{wh} | — | Clock Pulse Duration, High | 2 ⁴ | — | 3 ⁴ | — | 5 | — | ns |
| t_{wl} | — | Clock Pulse Duration, Low | 2 ⁴ | — | 3 ⁴ | — | 5 | — | ns |
| t_{en} | B | Input or I/O to Output Enabled | — | 4.5 | — | 6 | — | 9 | ns |
| | B | \overline{OE} to Output Enabled | — | 4.5 | — | 6 | — | 6 | ns |
| t_{dis} | C | Input or I/O to Output Disabled | — | 4.5 | — | 5 | — | 9 | ns |
| | C | \overline{OE} to Output Disabled | — | 4.5 | — | 5 | — | 6 | ns |

- 1) Refer to **Switching Test Conditions** section.
- 2) Calculated from f_{max} with internal feedback. Refer to **f_{max} Descriptions** section.
- 3) Refer to **f_{max} Descriptions** section. Characterized but not 100% tested.
- 4) Characterized but not 100% tested.

Capacitance (T_A = 25°C, f = 1.0 MHz)

| SYMBOL | PARAMETER | MAXIMUM* | UNITS | TEST CONDITIONS |
|------------------|-------------------|----------|-------|---|
| C _I | Input Capacitance | 8 | pF | V _{CC} = 5.0V, V _I = 2.0V |
| C _{I/O} | I/O Capacitance | 8 | pF | V _{CC} = 5.0V, V _{I/O} = 2.0V |

*Characterized but not 100% tested.

AC Switching Characteristics

Over Recommended Operating Conditions

| PARAM. | TEST COND ¹ . | DESCRIPTION | COM / IND | | COM / IND | | IND | | COM / IND | | UNITS |
|------------------------------------|--------------------------|--|-----------|------|-----------|------|------|------|-----------|------|-------|
| | | | -10 | | -15 | | -20 | | -25 | | |
| | | | MIN. | MAX. | MIN. | MAX. | MIN. | MAX. | MIN. | MAX. | |
| t_{pd} | A | Input or I/O to Comb. Output | 3 | 10 | 3 | 15 | 3 | 20 | 3 | 25 | ns |
| t_{co} | A | Clock to Output Delay | 2 | 7 | 2 | 10 | 2 | 11 | 2 | 12 | ns |
| t_{cf}² | — | Clock to Feedback Delay | — | 6 | — | 8 | — | 9 | — | 10 | ns |
| t_{su} | — | Setup Time, Input or Fdbk before Clk↑ | 10 | — | 12 | — | 13 | — | 15 | — | ns |
| t_h | — | Hold Time, Input or Fdbk after Clk↑ | 0 | — | 0 | — | 0 | — | 0 | — | ns |
| f_{max}³ | A | Maximum Clock Frequency with External Feedback, 1/(t _{su} + t _{co}) | 58.8 | — | 45.5 | — | 41.6 | — | 37 | — | MHz |
| | A | Maximum Clock Frequency with Internal Feedback, 1/(t _{su} + t _{cf}) | 62.5 | — | 50 | — | 45.4 | — | 40 | — | MHz |
| | A | Maximum Clock Frequency with No Feedback | 62.5 | — | 62.5 | — | 50 | — | 41.6 | — | MHz |
| t_{wh} | — | Clock Pulse Duration, High | 8 | — | 8 | — | 10 | — | 12 | — | ns |
| t_{wl} | — | Clock Pulse Duration, Low | 8 | — | 8 | — | 10 | — | 12 | — | ns |
| t_{en} | B | Input or I/O to Output Enabled | — | 10 | — | 15 | — | 18 | — | 20 | ns |
| | B | \overline{OE} to Output Enabled | — | 10 | — | 15 | — | 18 | — | 20 | ns |
| t_{dis} | C | Input or I/O to Output Disabled | — | 10 | — | 15 | — | 18 | — | 20 | ns |
| | C | \overline{OE} to Output Disabled | — | 10 | — | 15 | — | 18 | — | 20 | ns |

1) Refer to **Switching Test Conditions** section.

2) Calculated from f_{max} with internal feedback. Refer to **f_{max} Descriptions** section.

3) Refer to **f_{max} Descriptions** section. Characterized but not 100% tested.

Capacitance (T_A = 25°C, f = 1.0 MHz)

| SYMBOL | PARAMETER | MAXIMUM* | UNITS | TEST CONDITIONS |
|------------------|-------------------|----------|-------|---|
| C _I | Input Capacitance | 8 | pF | V _{CC} = 5.0V, V _I = 2.0V |
| C _{I/O} | I/O Capacitance | 8 | pF | V _{CC} = 5.0V, V _{I/O} = 2.0V |

*Characterized but not 100% tested.

Switching Waveforms

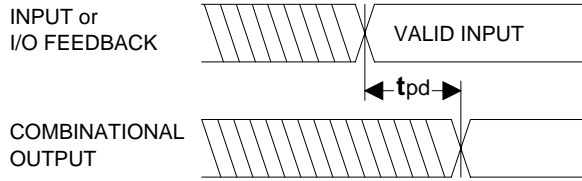

Combinatorial Output

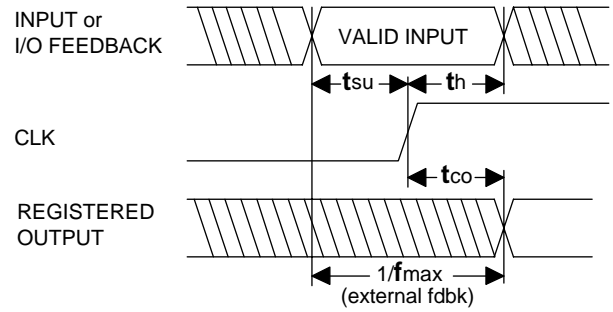

Registered Output

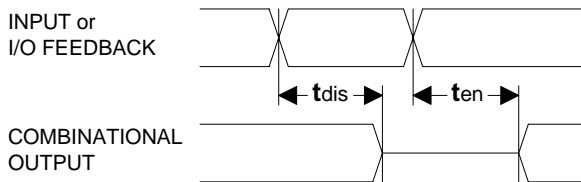

Input or I/O to Output Enable/Disable

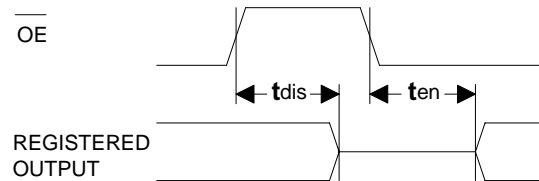

\overline{OE} to Output Enable/Disable

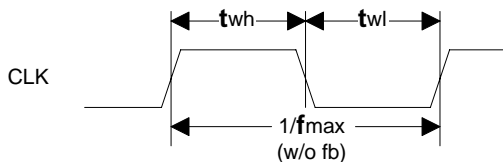

Clock Width

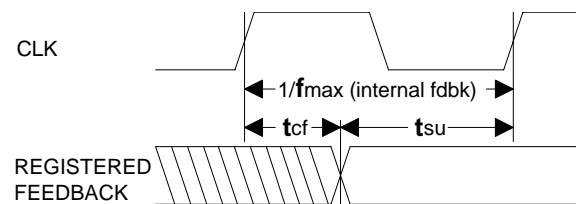

f_{max} with Feedback

fmax Descriptions

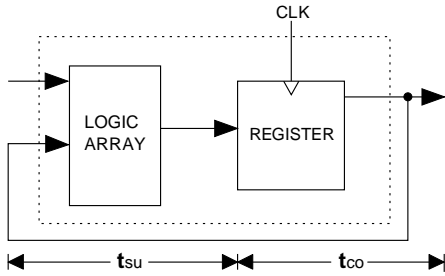

fmax with External Feedback $1/(t_{su}+t_{co})$

Note: fmax with external feedback is calculated from measured tsu and tco.

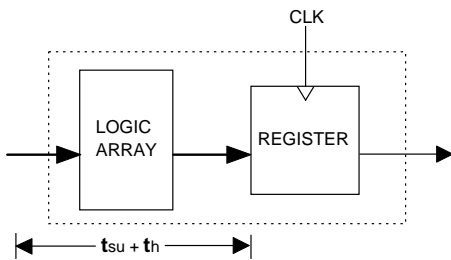

fmax with No Feedback

Note: fmax with no feedback may be less than $1/(t_{wh} + t_{wl})$. This is to allow for a clock duty cycle of other than 50%.

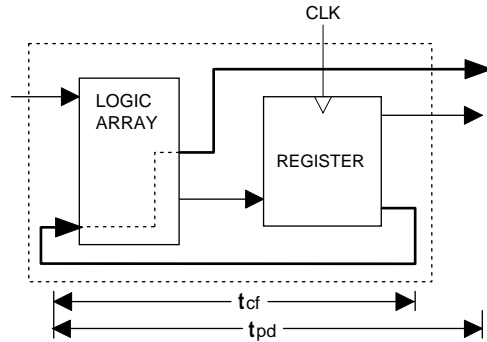

fmax with Internal Feedback $1/(t_{su}+t_{cf})$

Note: tcf is a calculated value, derived by subtracting tsu from the period of fmax w/internal feedback ($t_{cf} = 1/f_{max} - t_{su}$). The value of tcf is used primarily when calculating the delay from clocking a register to a combinational output (through registered feedback), as shown above. For example, the timing from clock to a combinational output is equal to $t_{cf} + t_{pd}$.

Switching Test Conditions

| Input Pulse Levels | | GND to 3.0V |
|--------------------------------|--------------------------|---------------------|
| Input Rise and Fall Times | GAL16V8D-10 (and slower) | 2 – 3ns 10% – 90% |
| | GAL16V8D-3/-5/-7 | 1.5ns 10% – 90% |
| Input Timing Reference Levels | | 1.5V |
| Output Timing Reference Levels | | 1.5V |
| Output Load | | See figure at right |

3-state levels are measured 0.5V from steady-state active level.

Table 2-0003/16V8

GAL16V8D (except -3) Output Load Conditions (see figure above)

| Test Condition | R1 | R2 | CL |
|----------------|-------------|------|------|
| A | 200Ω | 390Ω | 50pF |
| B | Active High | ∞ | 390Ω |
| | Active Low | 200Ω | 390Ω |
| C | Active High | ∞ | 5pF |
| | Active Low | 200Ω | 390Ω |

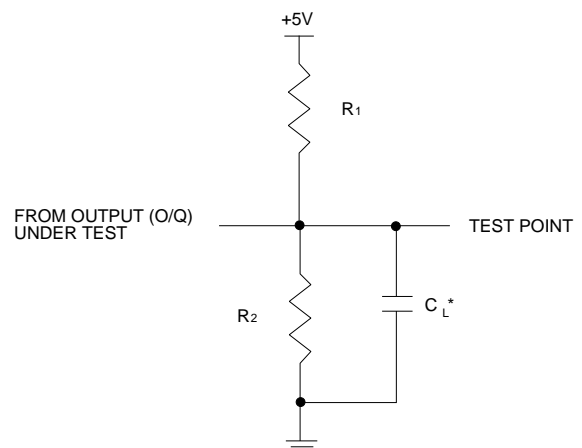

*CL INCLUDES TEST FIXTURE AND PROBE CAPACITANCE

Switching Test Conditions (Continued)

GAL16V8D-3 Output Load Conditions (see figure at right)

| Test Condition | R ₁ | C _L |
|----------------|-------------------------------|----------------|
| A | 50Ω | 35pF |
| B | High Z to Active High at 1.9V | 50Ω |
| | High Z to Active Low at 1.0V | 35pF |
| C | Active High to High Z at 1.9V | 50Ω |
| | Active Low to High Z at 1.0V | 35pF |

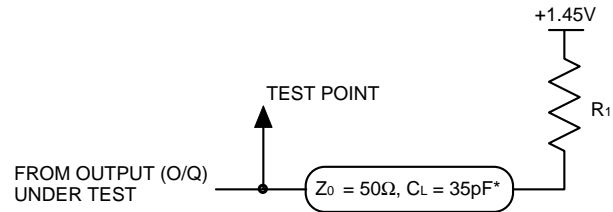

*C_L includes test fixture and probe capacitance.

Electronic Signature

An electronic signature is provided in every GAL16V8 device. It contains 64 bits of reprogrammable memory that can contain user defined data. Some uses include user ID codes, revision numbers, or inventory control. The signature data is always available to the user independent of the state of the security cell.

NOTE: The electronic signature is included in checksum calculations. Changing the electronic signature will alter the checksum.

Security Cell

A security cell is provided in the GAL16V8 devices to prevent unauthorized copying of the array patterns. Once programmed, this cell prevents further read access to the functional bits in the device. This cell can only be erased by re-programming the device, so the original configuration can never be examined once this cell is programmed. The Electronic Signature is always available to the user, regardless of the state of this control cell.

Latch-Up Protection

GAL16V8 devices are designed with an on-board charge pump to negatively bias the substrate. The negative bias minimizes the potential of latch-up caused by negative input undershoots. Additionally, outputs are designed with n-channel pull-ups instead of the traditional p-channel pull-ups in order to eliminate latch-up due to output overshoots.

Device Programming

GAL devices are programmed using a Lattice Semiconductor-approved Logic Programmer, available from a number of manufacturers. Complete programming of the device takes only a few seconds. Erasing of the device is transparent to the user, and is done automatically as part of the programming cycle.

Output Register Preload

When testing state machine designs, all possible states and state transitions must be verified in the design, not just those required in the normal machine operations. This is because, in system operation, certain events occur that may throw the logic into an illegal state (power-up, line voltage glitches, brown-outs, etc.). To test a design for proper treatment of these conditions, a way must be provided to break the feedback paths, and force any desired (i.e., illegal) state into the registers. Then the machine can be sequenced and the outputs tested for correct next state conditions.

GAL16V8 devices include circuitry that allows each registered output to be synchronously set either high or low. Thus, any present state condition can be forced for test sequencing. If necessary, approved GAL programmers capable of executing text vectors perform output register preload automatically.

Input Buffers

GAL16V8 devices are designed with TTL level compatible input buffers. These buffers have a characteristically high impedance, and present a much lighter load to the driving logic than bipolar TTL devices.

The GAL16V8 input and I/O pins have built-in active pull-ups. As a result, unused inputs and I/O's will float to a TTL "high" (logical "1"). Lattice Semiconductor recommends that all unused inputs and tri-stated I/O pins be connected to another active input, V_{CC}, or Ground. Doing this will tend to improve noise immunity and reduce I_{CC} for the device.

Typical Input Pull-up Characteristic

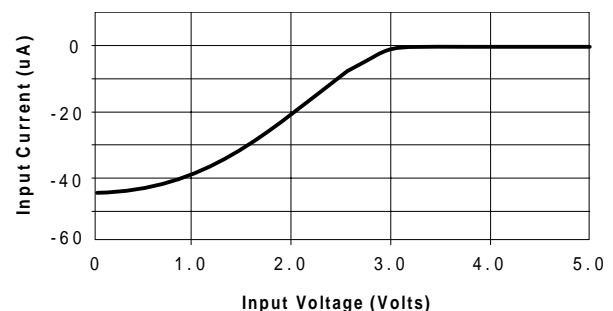

Power-Up Reset

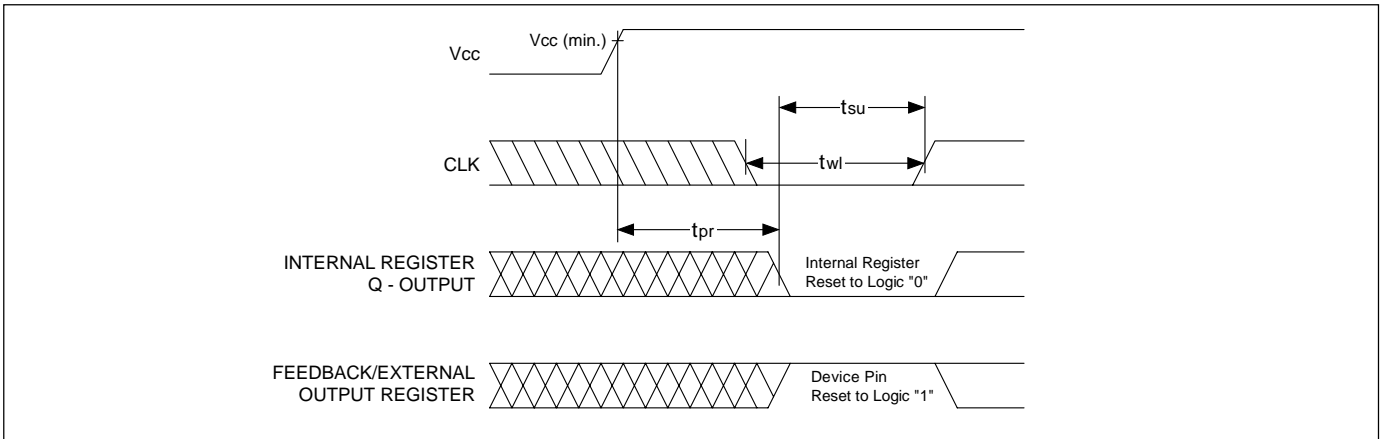

Circuitry within the GAL16V8 provides a reset signal to all registers during power-up. All internal registers will have their Q outputs set low after a specified time (t_{pr} , 1 μs MAX). As a result, the state on the registered output pins (if they are enabled) will always be high on power-up, regardless of the programmed polarity of the output pins. This feature can greatly simplify state machine design by providing a known state on power-up. Because of the asynchronous nature of system power-up, some

conditions must be met to provide a valid power-up reset of the device. First, the V_{cc} rise must be monotonic. Second, the clock input must be at static TTL level as shown in the diagram during power up. The registers will reset within a maximum of t_{pr} time. As in normal system operation, avoid clocking the device until all input and feedback path setup times have been met. The clock must also meet the minimum pulse width requirements.

Input/Output Equivalent Schematics

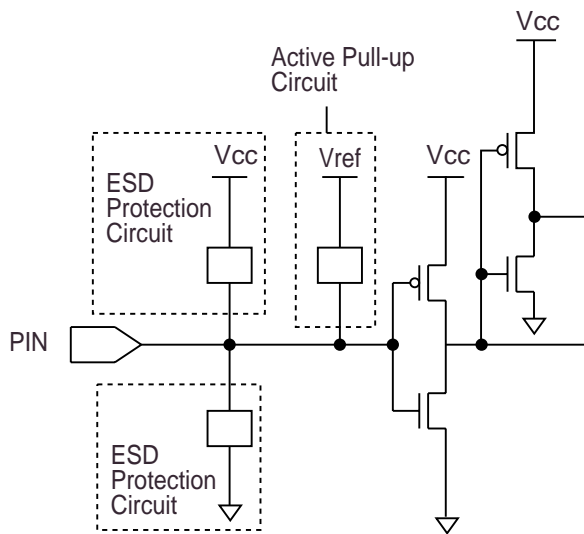
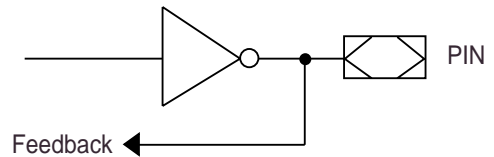
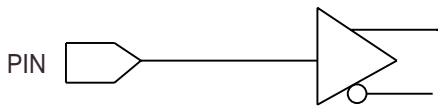

Typ. $V_{ref} = 3.2\text{V}$

Typical Input

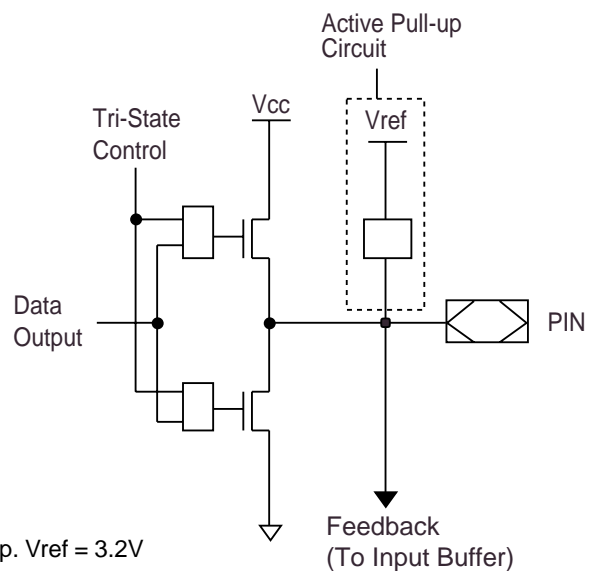

Typ. $V_{ref} = 3.2\text{V}$

Typical Output

GAL16V8D-3/-5/-7 (IND PLCC): Typical AC and DC Characteristic Diagrams

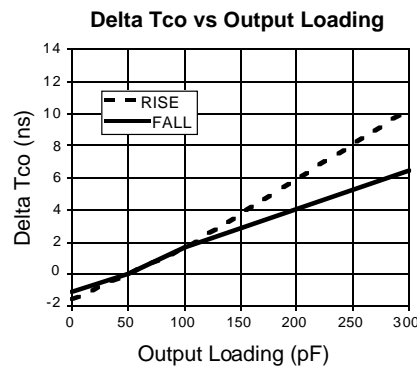
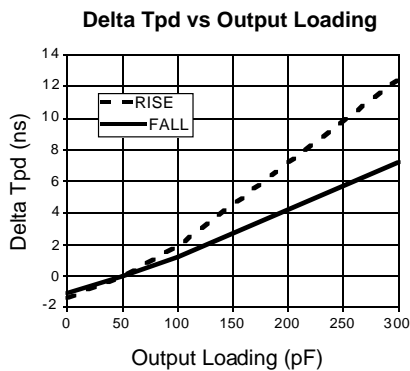
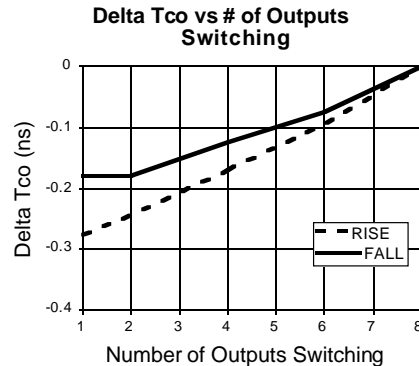
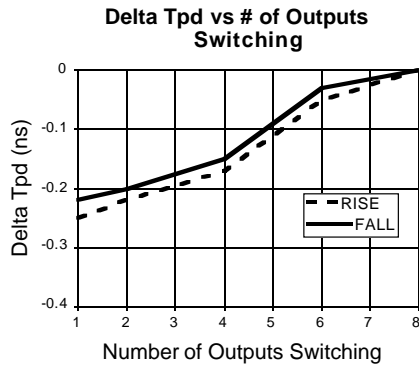
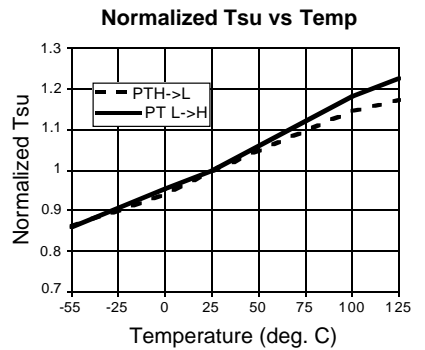
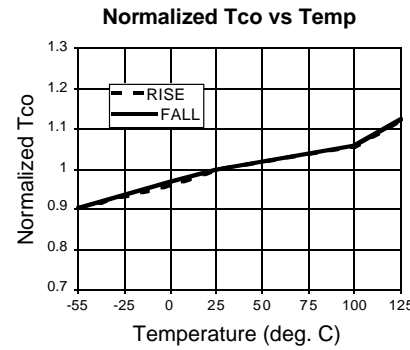
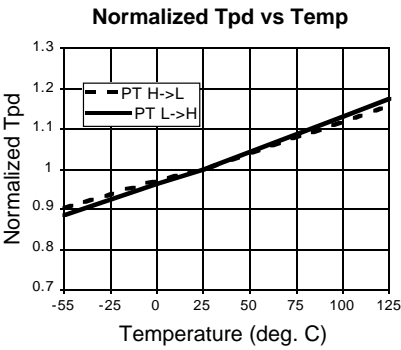
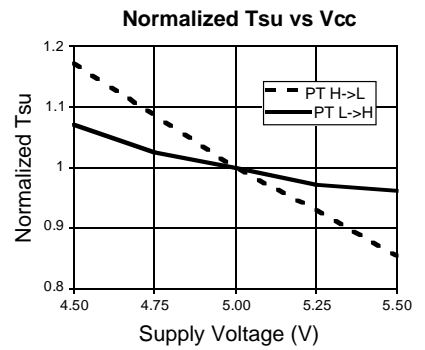
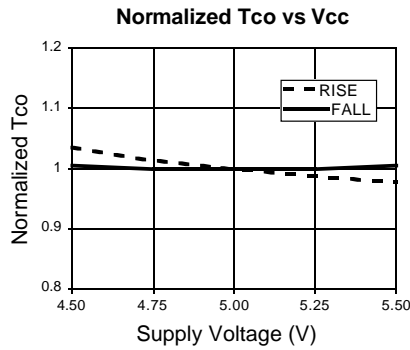
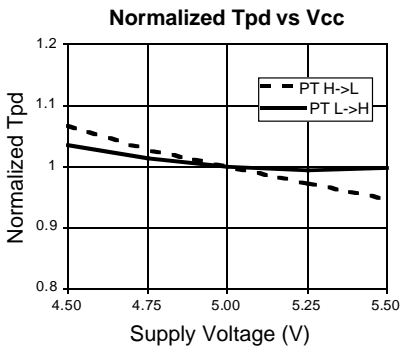

GAL16V8D-3/-5/-7 (IND PLCC): Typical AC and DC Characteristic Diagrams

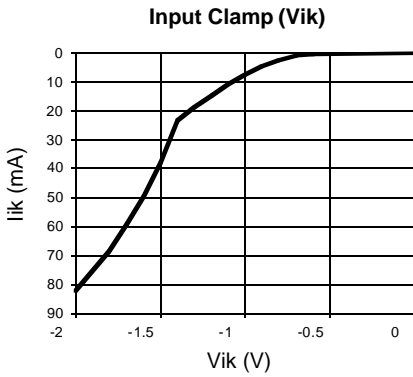
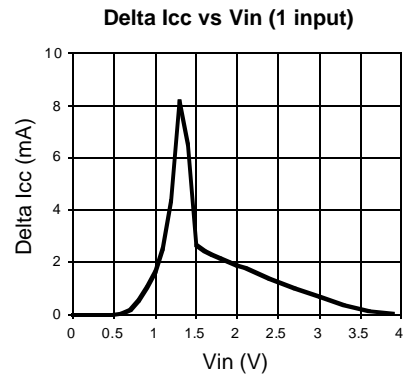
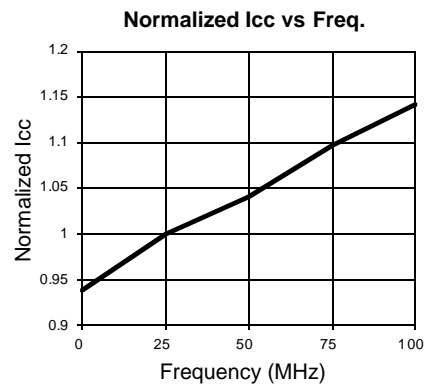
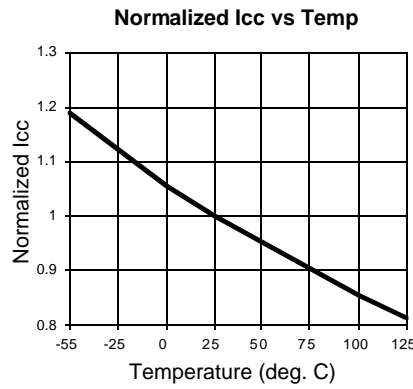
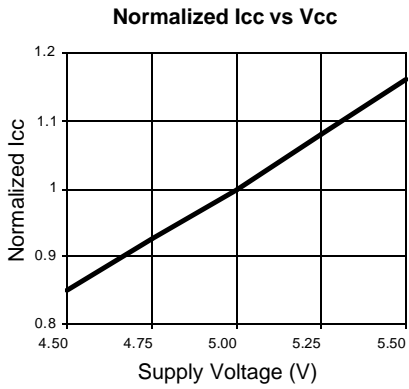
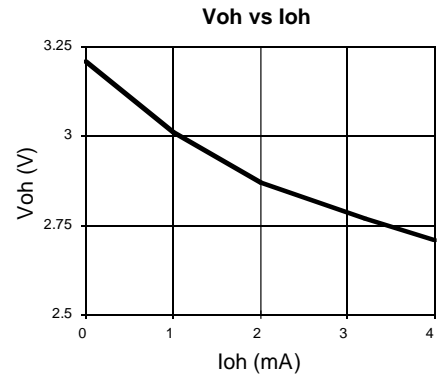
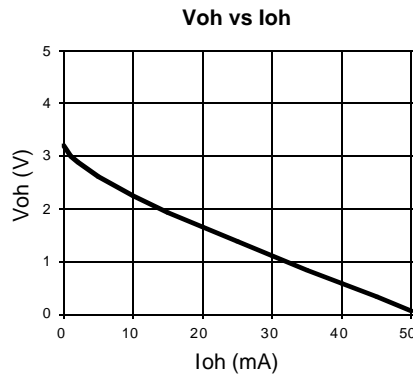
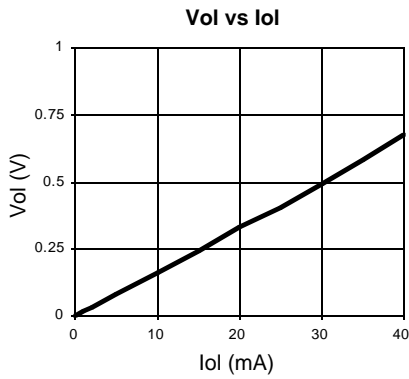

GAL16V8D-7 (Except IND PLCC)/-10L: Typical AC and DC Characteristic Diagrams

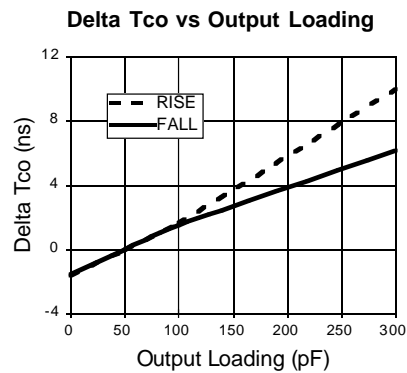
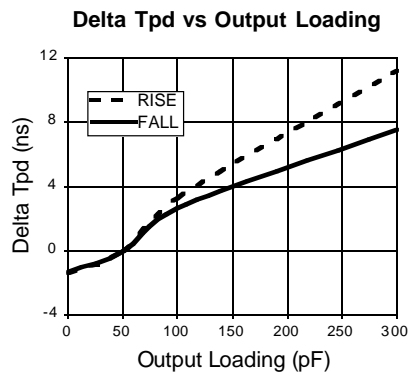
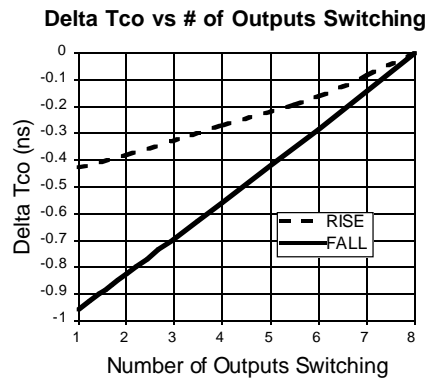
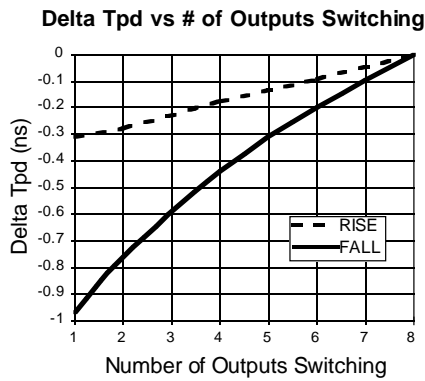
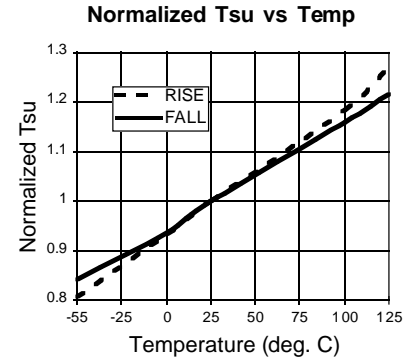
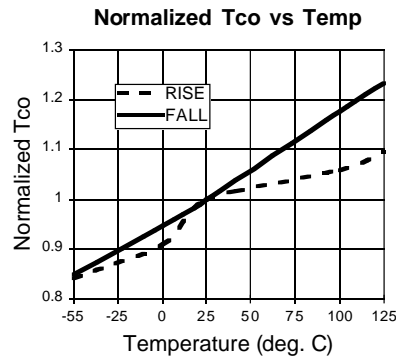
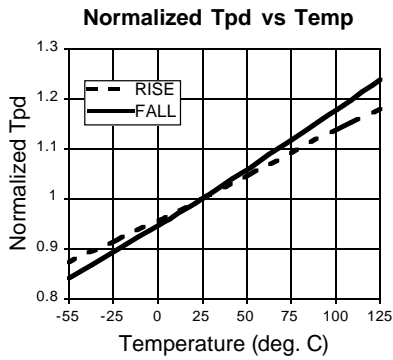
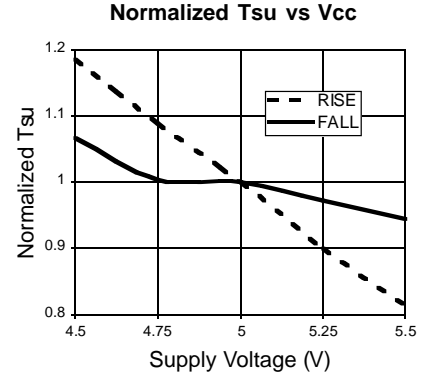
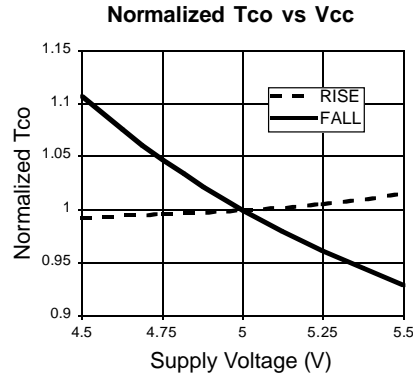
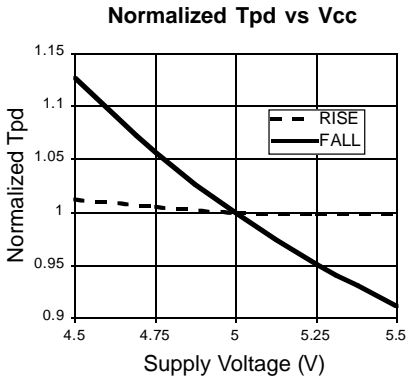

GAL16V8D-7 (Except IND PLCC)/-10L: Typical AC and DC Characteristic Diagrams

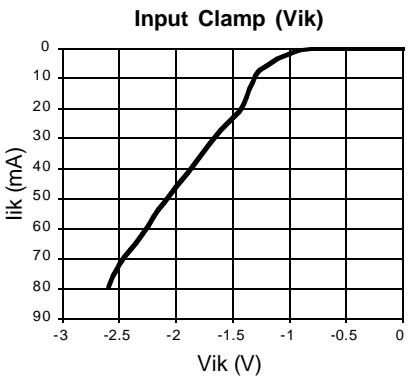
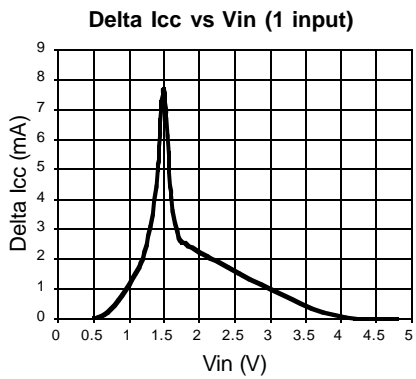
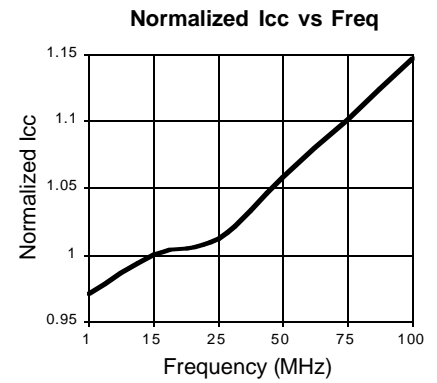
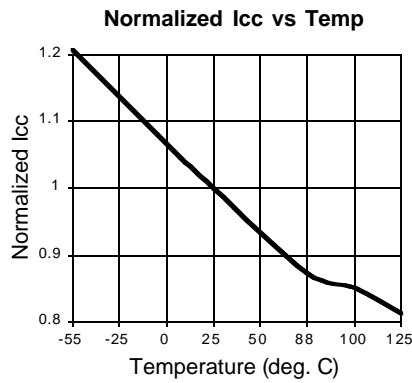
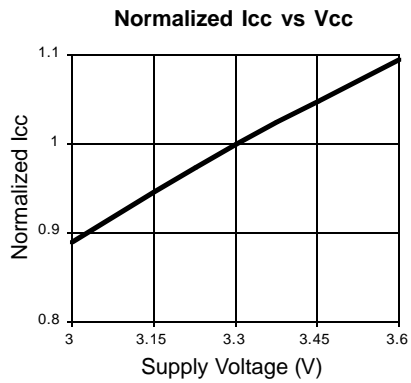
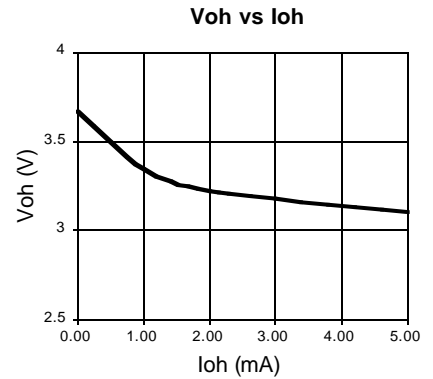
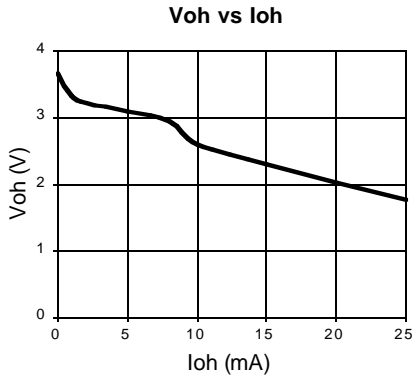
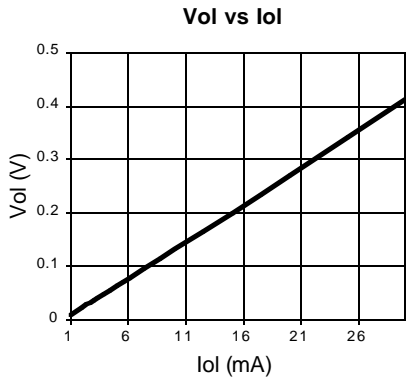

GAL16V8D-10Q (and Slower): Typical AC and DC Characteristic Diagrams

Normalized Tpd vs Vcc

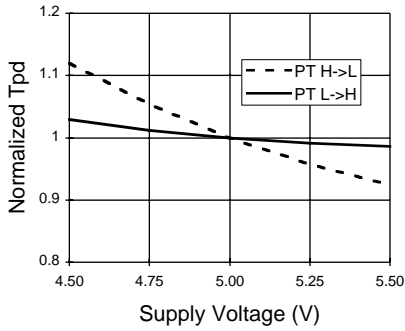

Normalized Tco vs Vcc

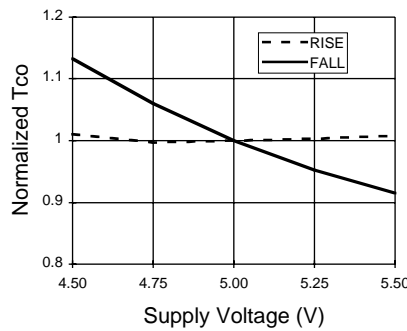

Normalized Tsu vs Vcc

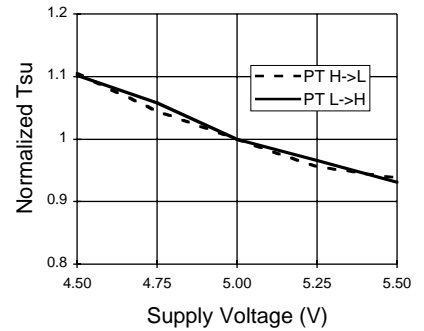

Normalized Tpd vs Temp

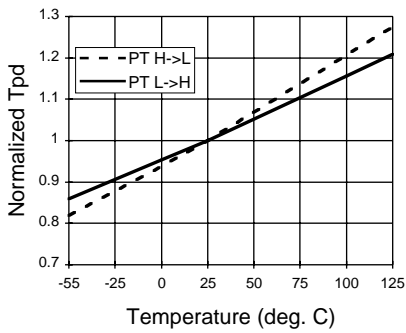

Normalized Tco vs Temp

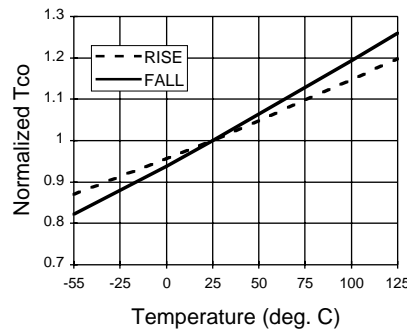

Normalized Tsu vs Temp

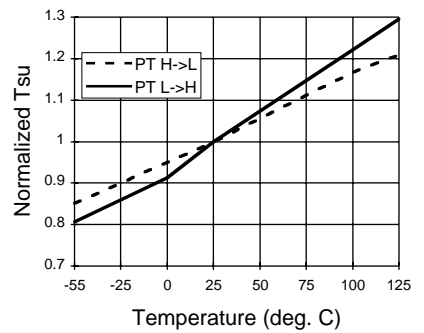

Delta Tpd vs # of Outputs Switching

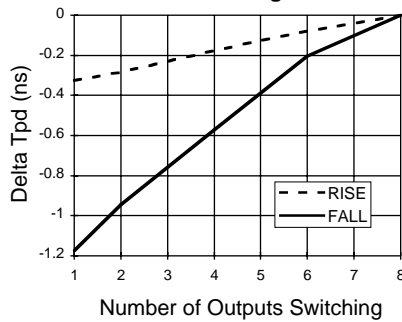

Delta Tco vs # of Outputs Switching

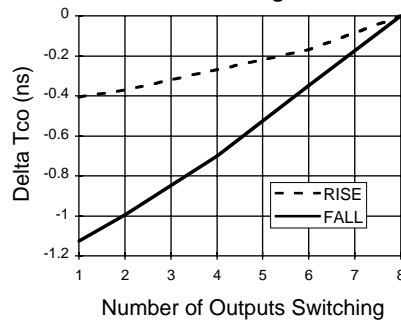

Delta Tpd vs Output Loading

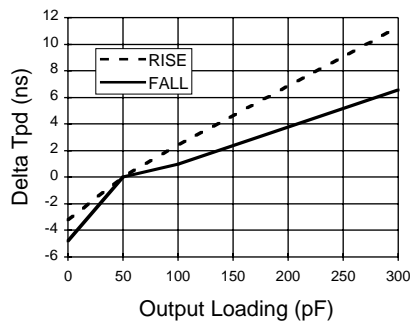

Delta Tco vs Output Loading

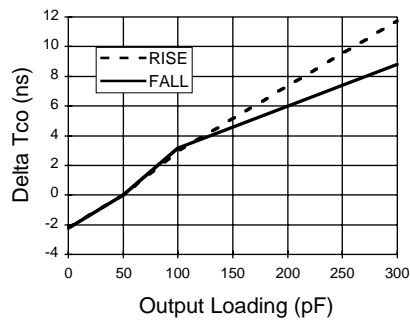

GAL16V8D-10Q (and Slower): Typical AC and DC Characteristic Diagrams

Vol vs Iol

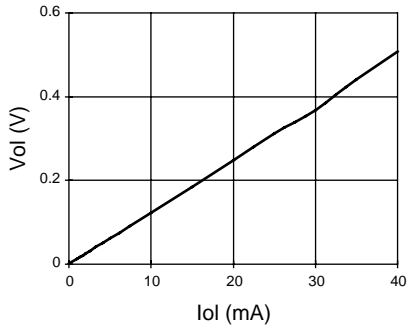

Voh vs Ioh

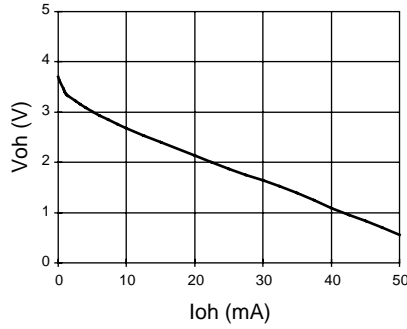

Voh vs Ioh

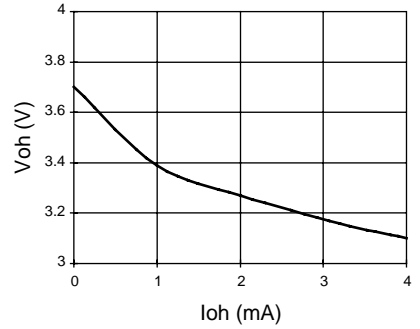

Normalized Icc vs Vcc

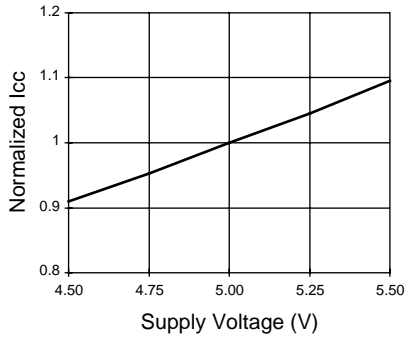

Normalized Icc vs Temp

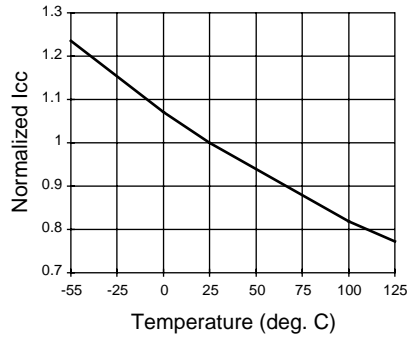

Normalized Icc vs Freq.

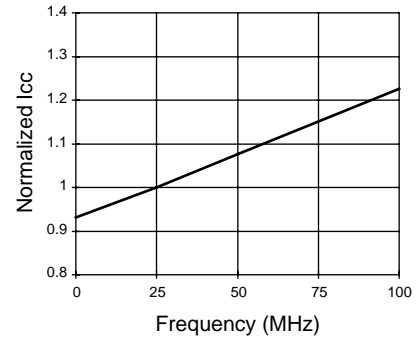

Delta Icc vs Vin (1 input)

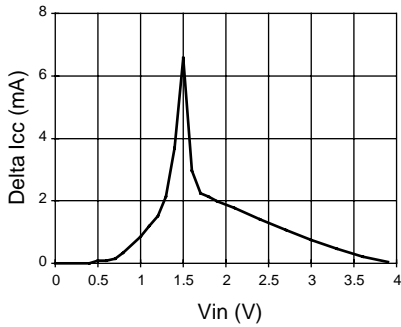

Input Clamp (Iik)

